











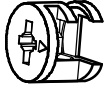
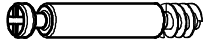

 Ø6,3x50 mm A1 x 44	 Ø12 mm A2 x 44	 4 mm A3 x 1	 Ø15x12 mm B1 x 12	 Ø5x44 mm B2 x 12
 Ø20 mm B3 x 12	 Ø12x3 mm C x 5	 Ø3x16 mm D1 x 16	 Ø4x16 mm D2 x 48	 Ø4x20 mm D3 x 5
 Ø4,2x32 mm D4 x 10	 Ø1,6x20 mm F x 238	 Ø8x36 mm G x 23	 H x 5	 I x 2
 K x 2	 Ø5x16 mm L x 14	 M1 x 6	 M2 x 3	
 Ø15 mm N x 8	 774 mm O1 x 1	 420 mm O2 x 1	 942 mm P x 1	

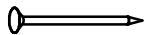

Box 1 / 3

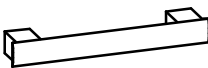
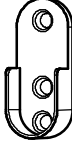
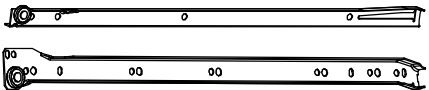
1498x498x16 mm

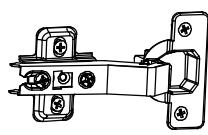
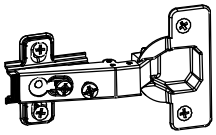

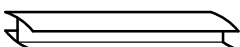
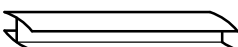
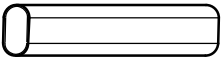
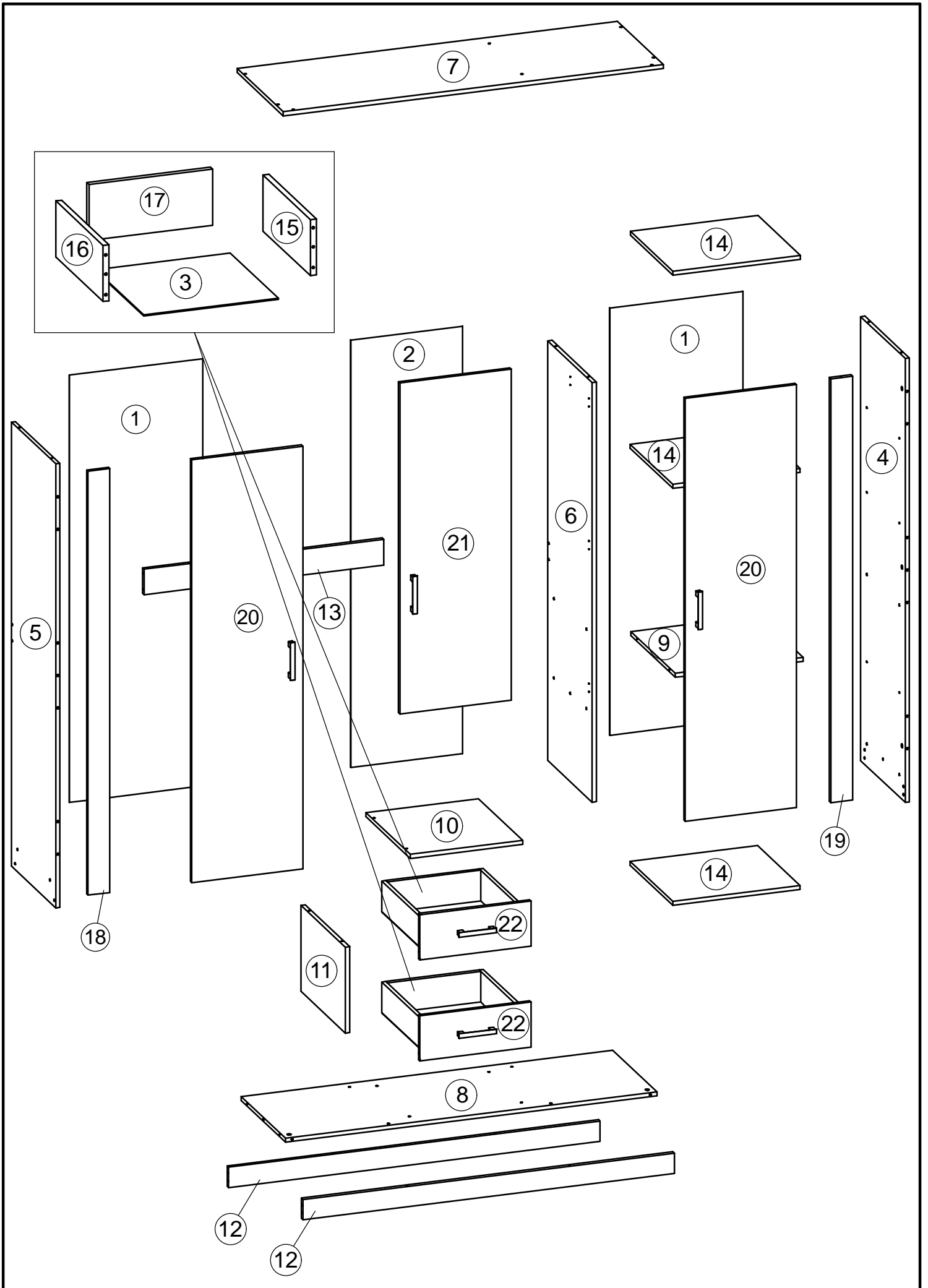
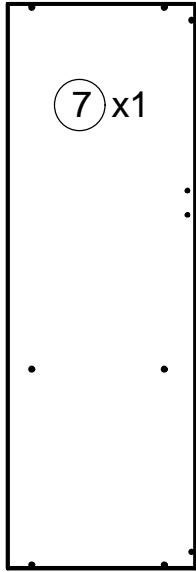
1464x480x16 mm

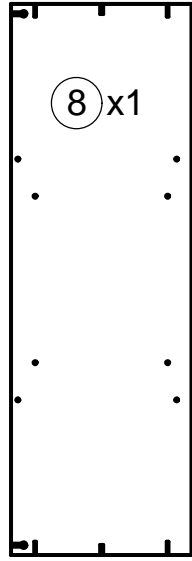

503x480x16 mm

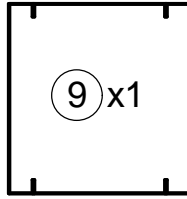

339x480x16 mm

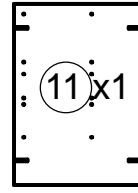

80x1464x16 mm

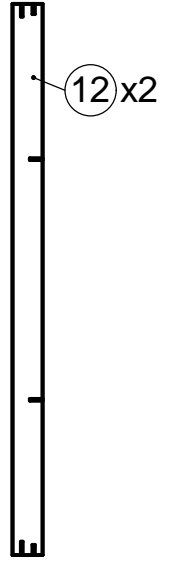

442x480x16 mm

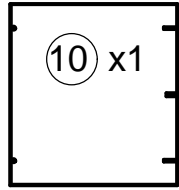

502x460x16 mm

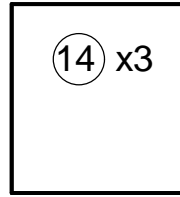

100x945x16 mm

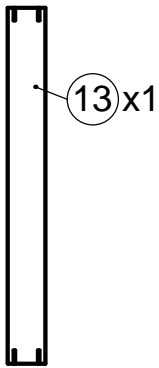

450x120x16 mm

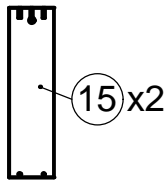

450x120x16 mm

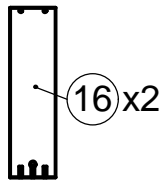

368x120x16 mm

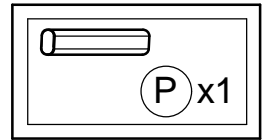
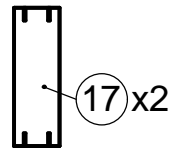

Fittings & Tools

Box 2 / 3

1750x480x16 mm

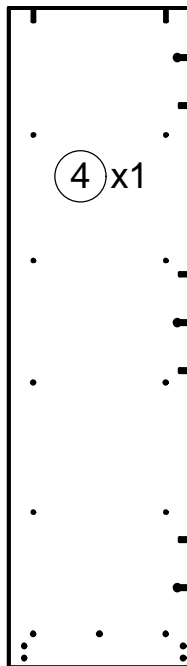

1750x480x16 mm

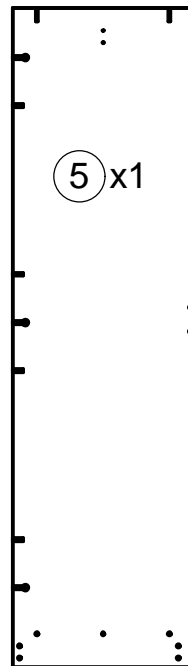

1654x480x16 mm

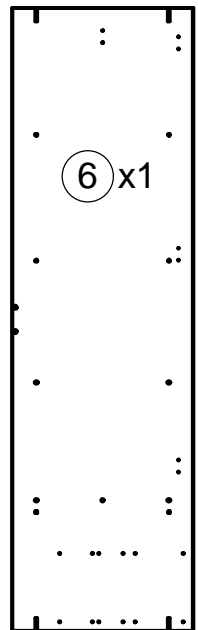

Box 3 / 3

1684x525x3 mm

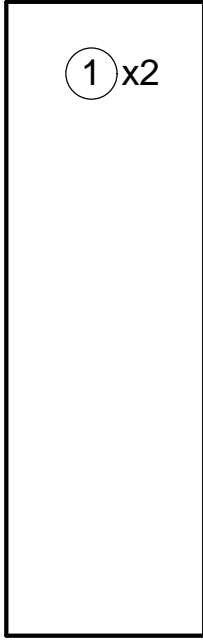

456x398x3 mm

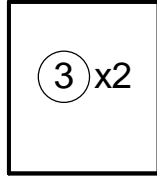

1684x441x3 mm

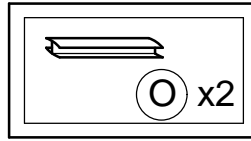
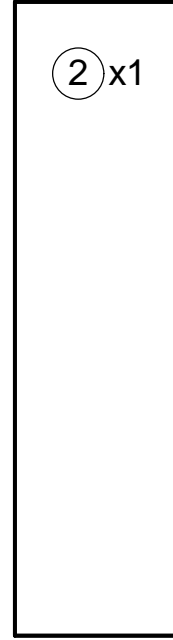

1670x85x16 mm

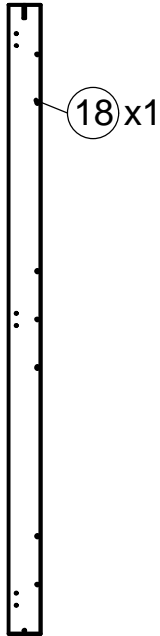

1670x85x16 mm

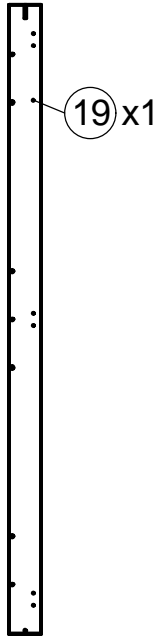

1665x437x16 mm

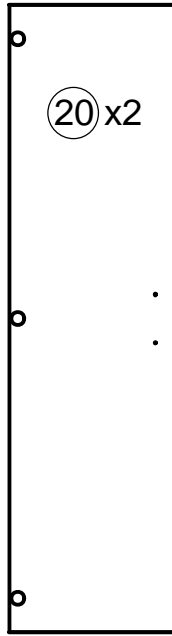

1303x437x16 mm

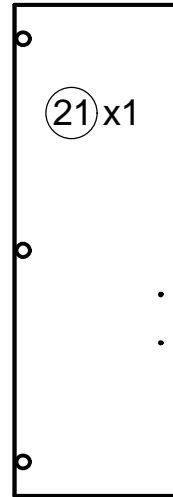

437x177x16 mm

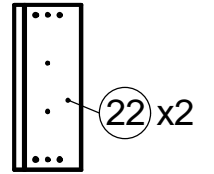

1

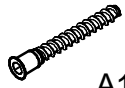

A1 x 4



A2 x 4



A3 x 1



B1 x 2

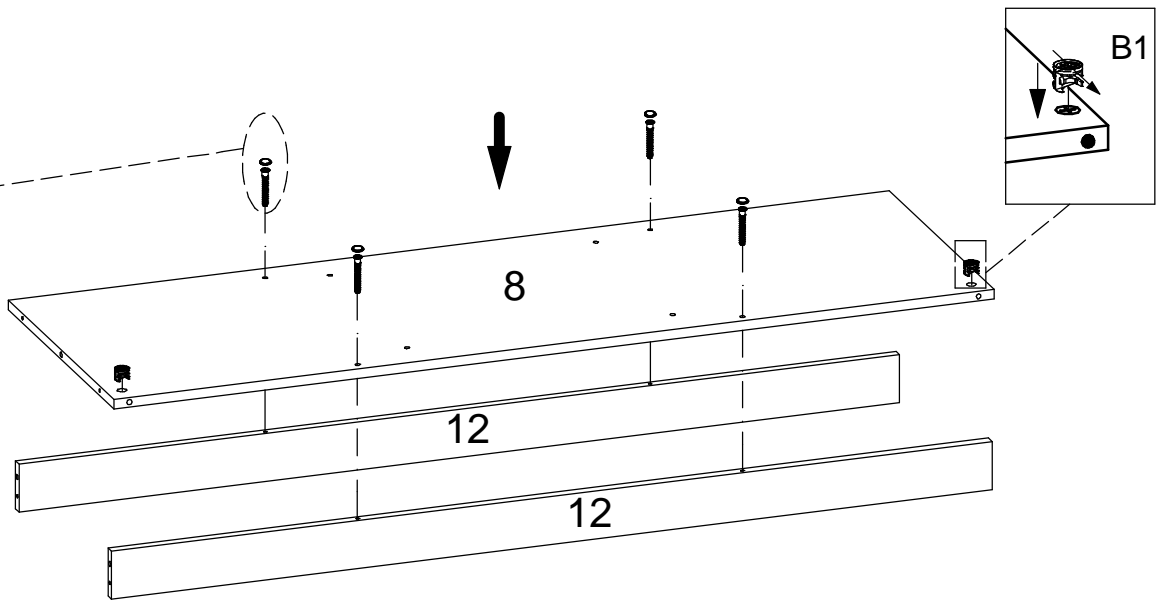
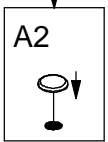
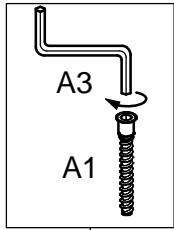

2

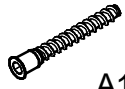

A1 x 2



A2 x 2



A3 x 1

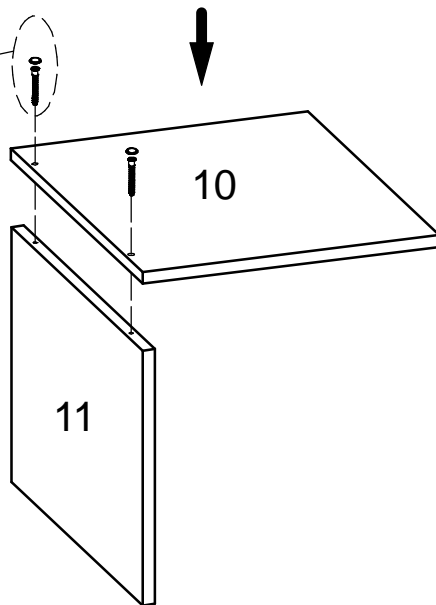
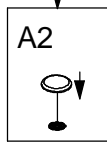
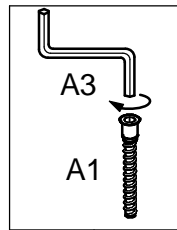
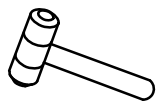

3

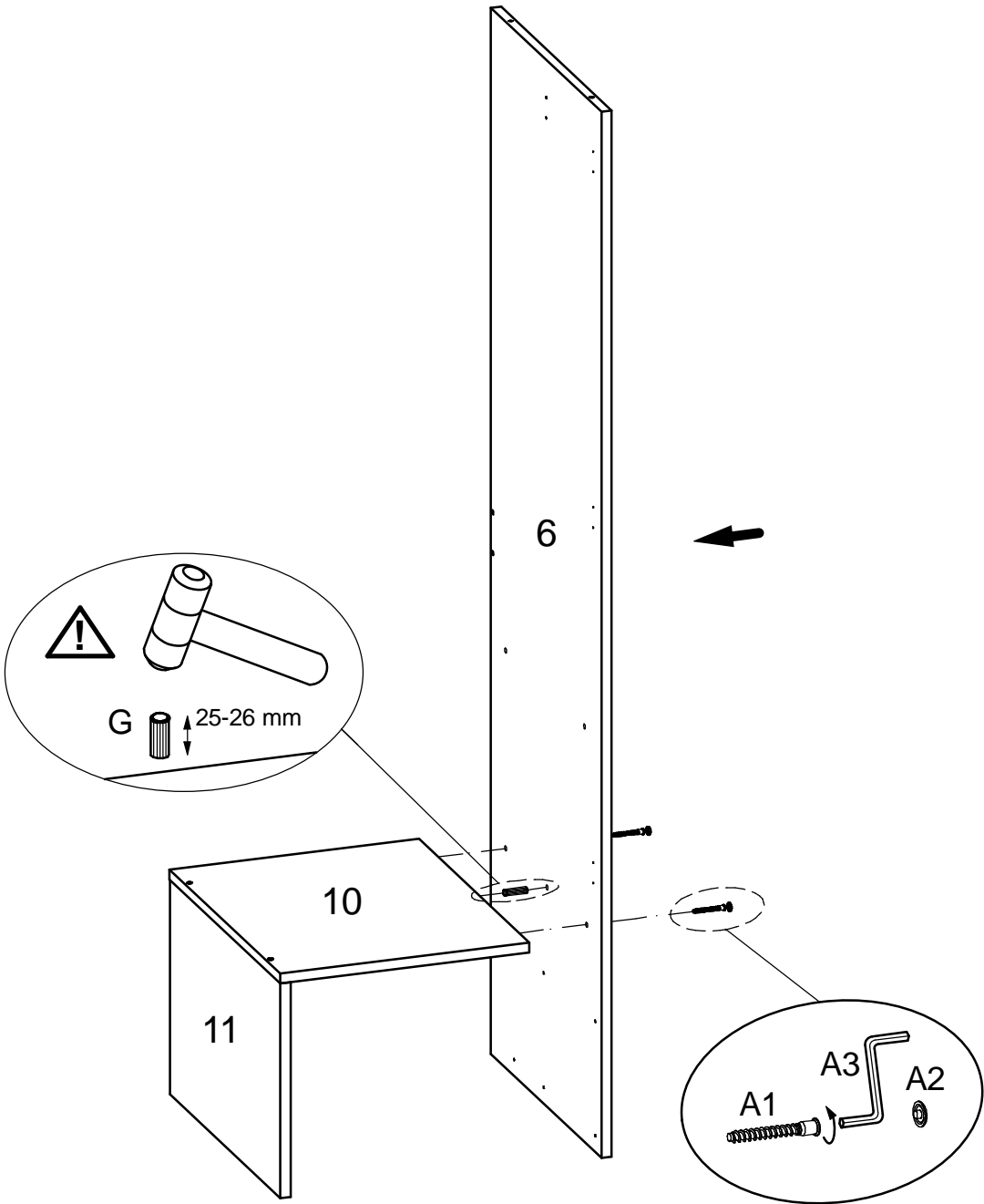
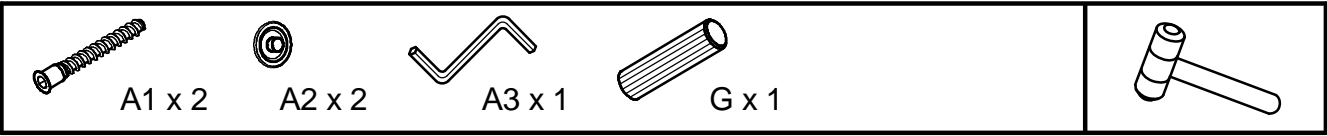

4

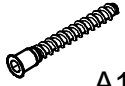

A1 x 4



A2 x 4



A3 x 1

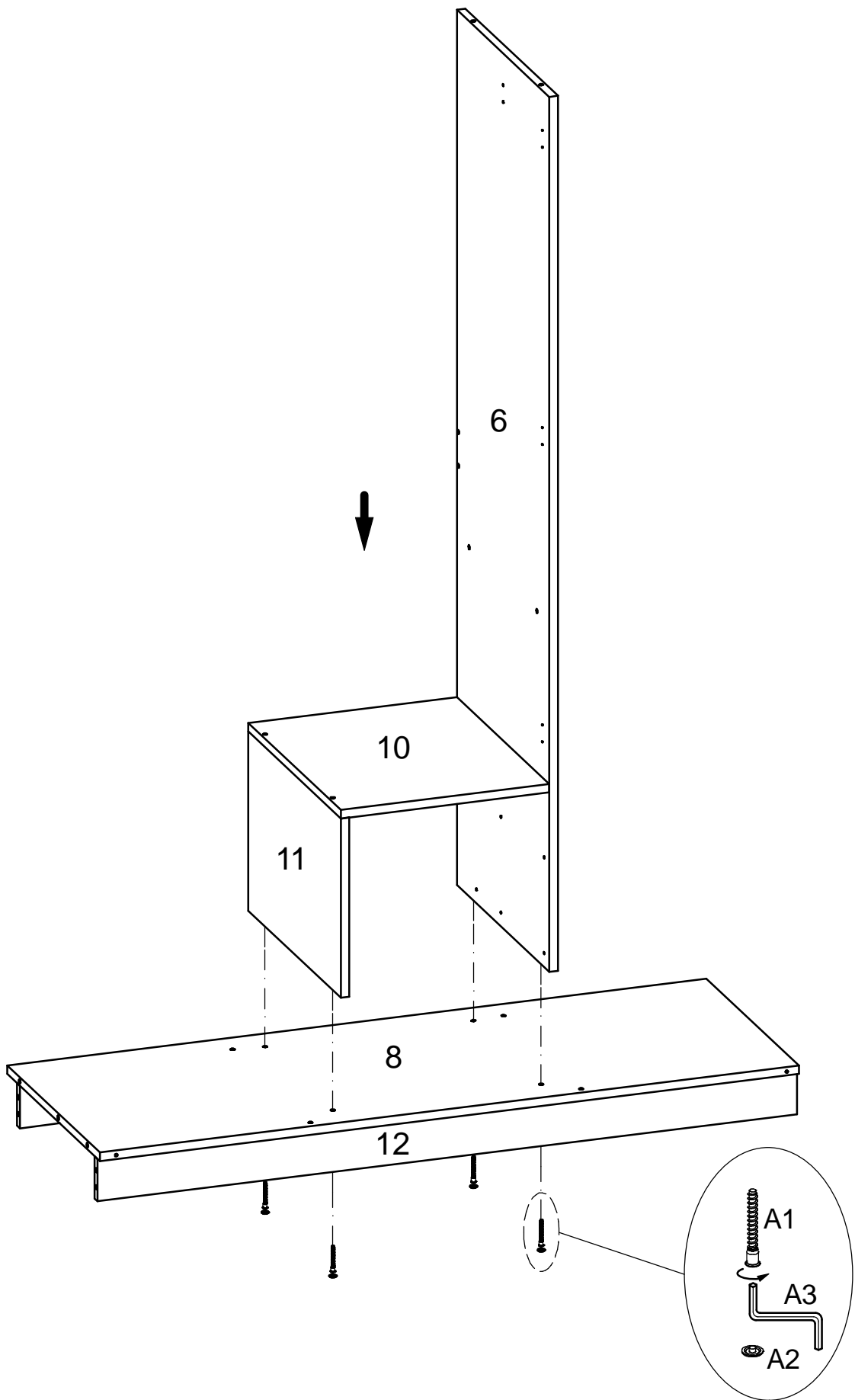
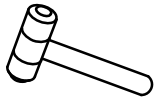

5



A1 x 16



A2 x 16



A3 x 1



D1 x 4

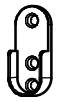

I x 2



G x 6

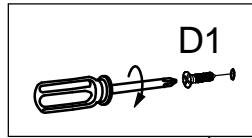
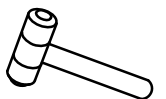
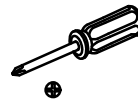

D1

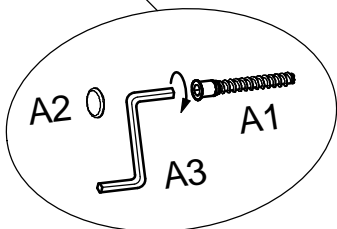
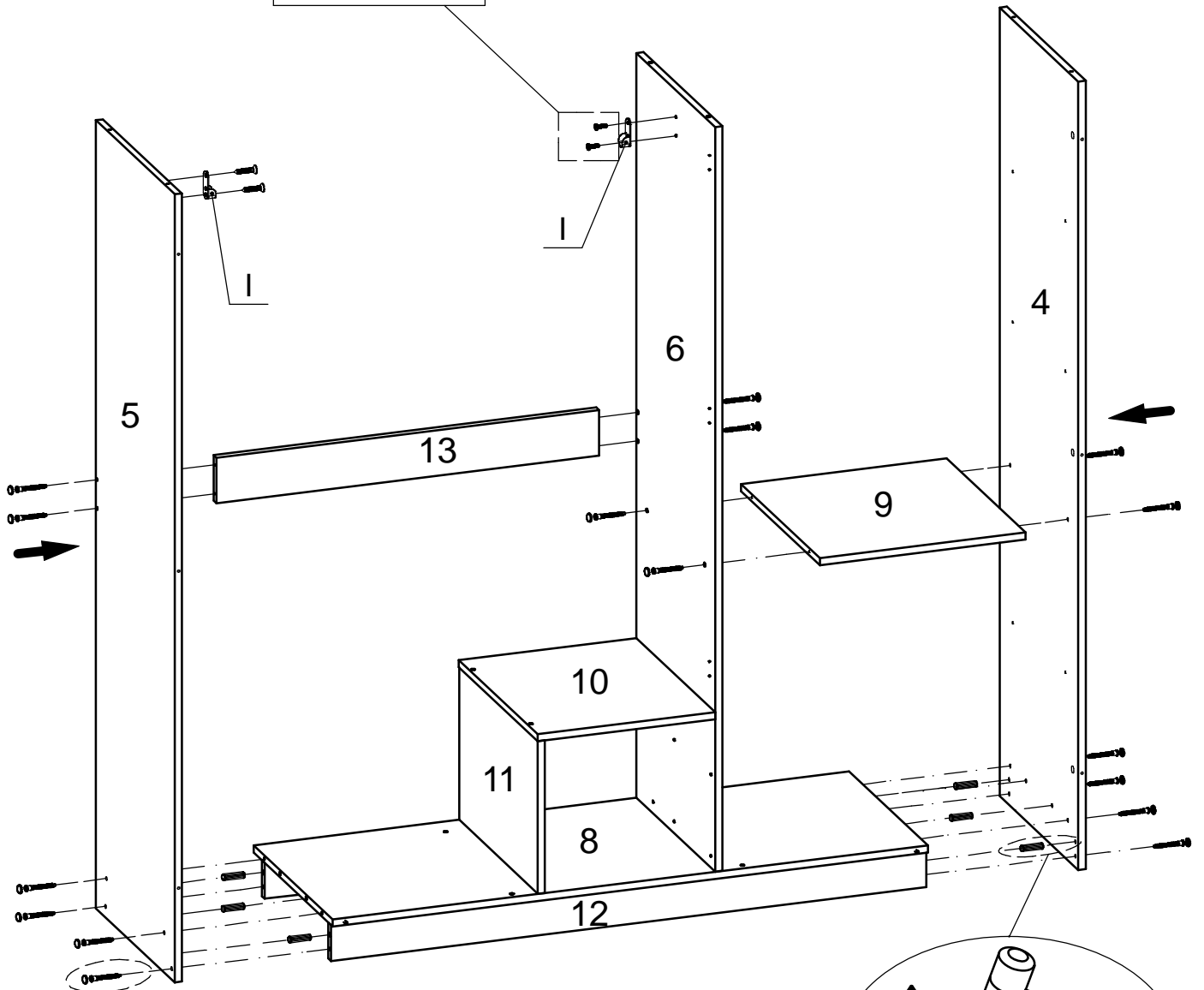

A2

A1

A3

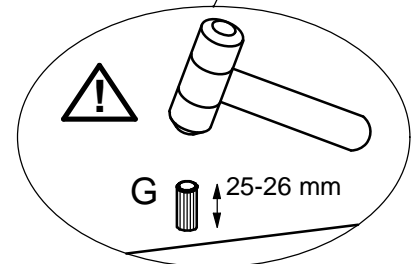

G

25-26 mm

6

D2 x 12

M1.1 x 6

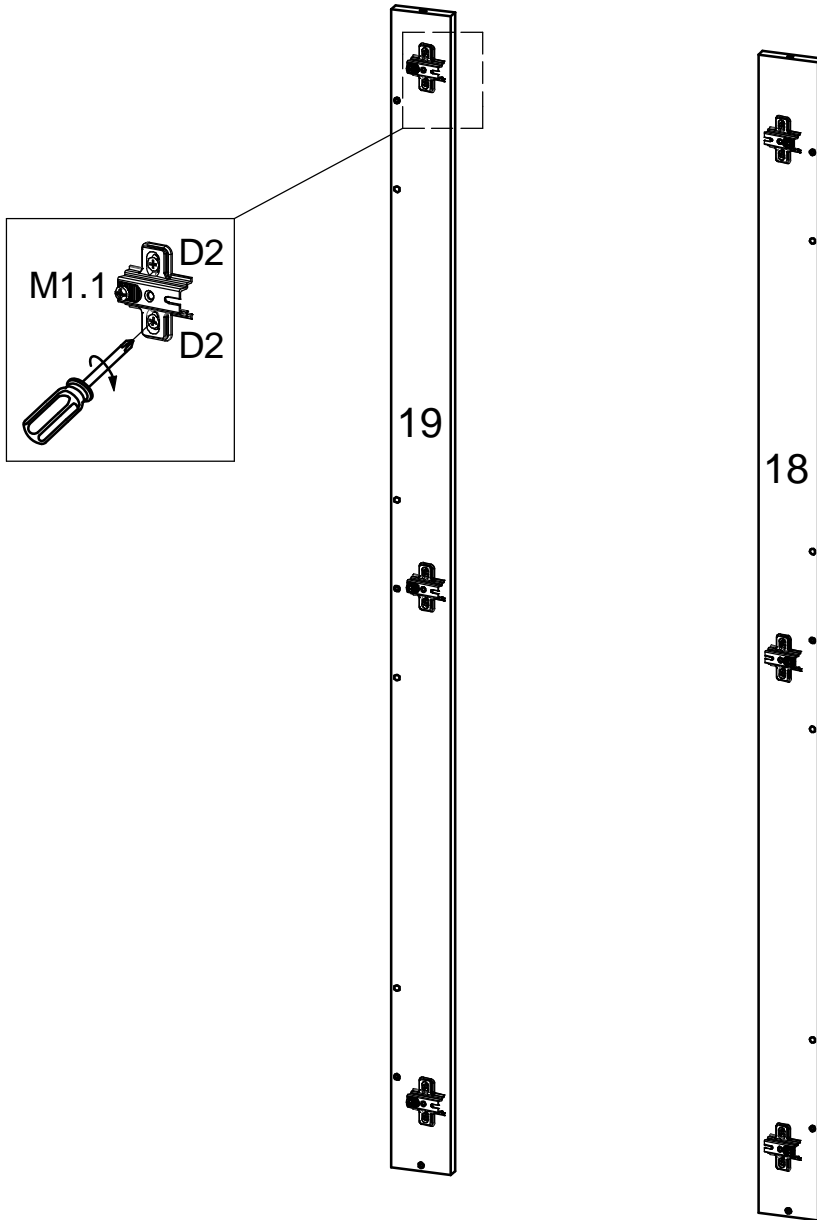
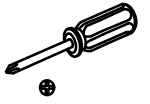

7



B1 x 6



B2 x 8



B3 x 8



G x 8



L x 12

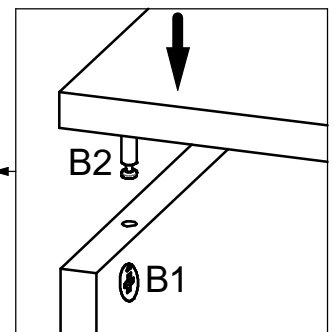
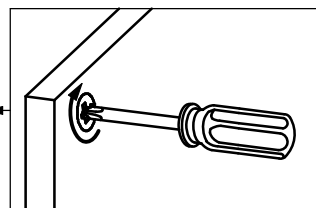
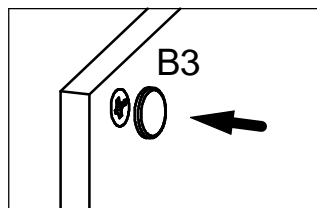
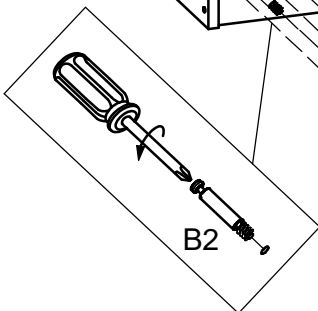
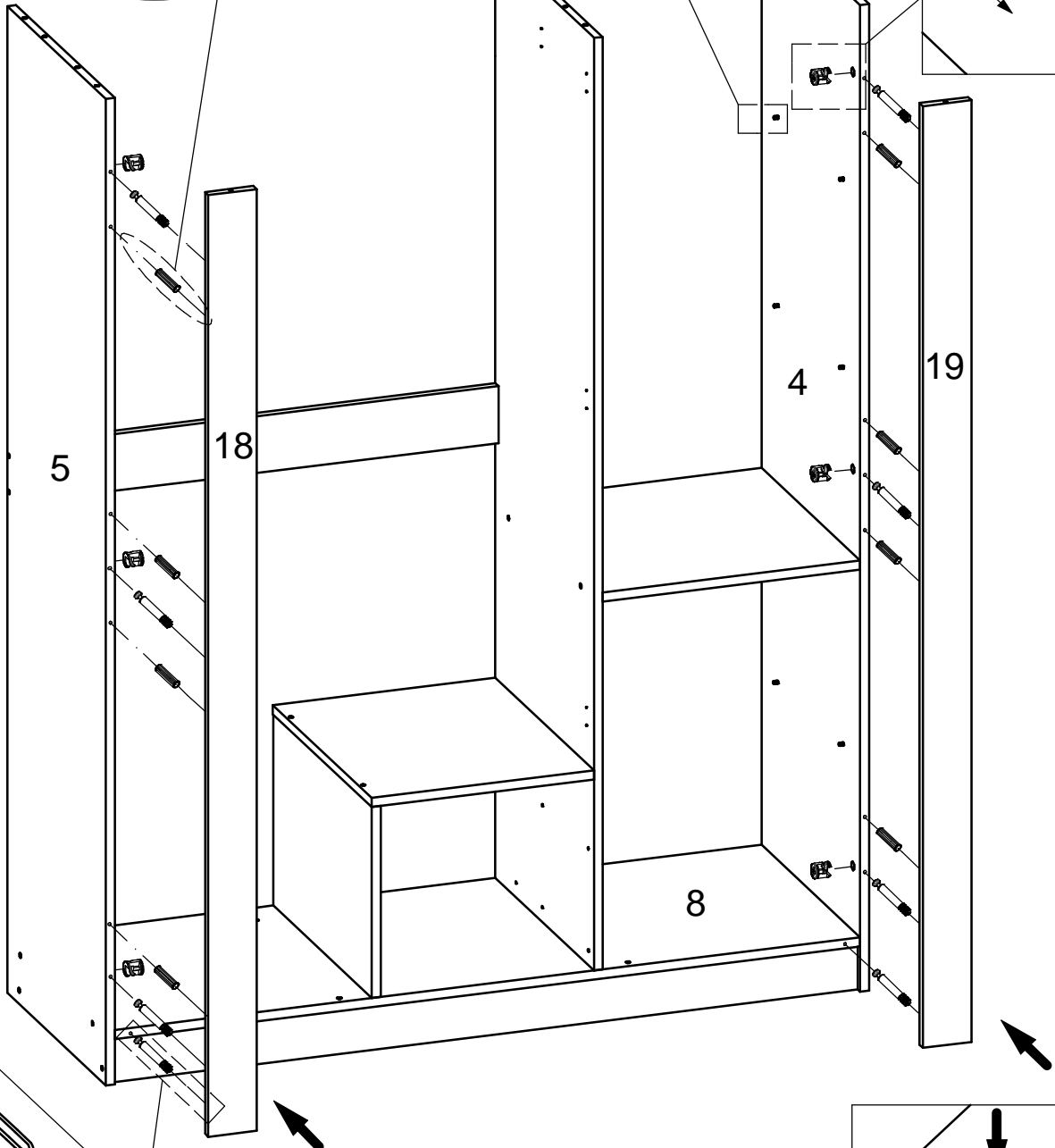
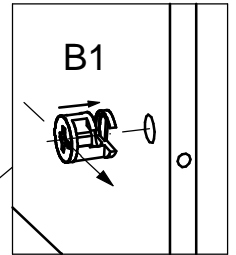
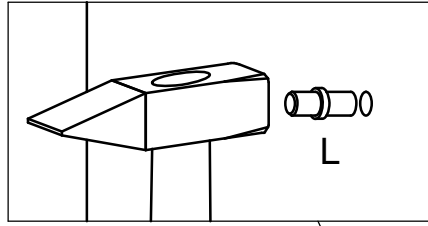
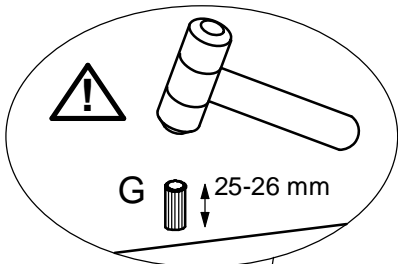
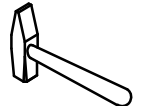
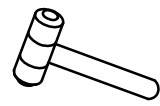
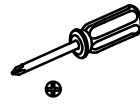

8

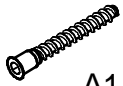

A1 x 8



A2 x 8



A3 x 1



L x 2

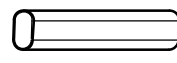

P x 1

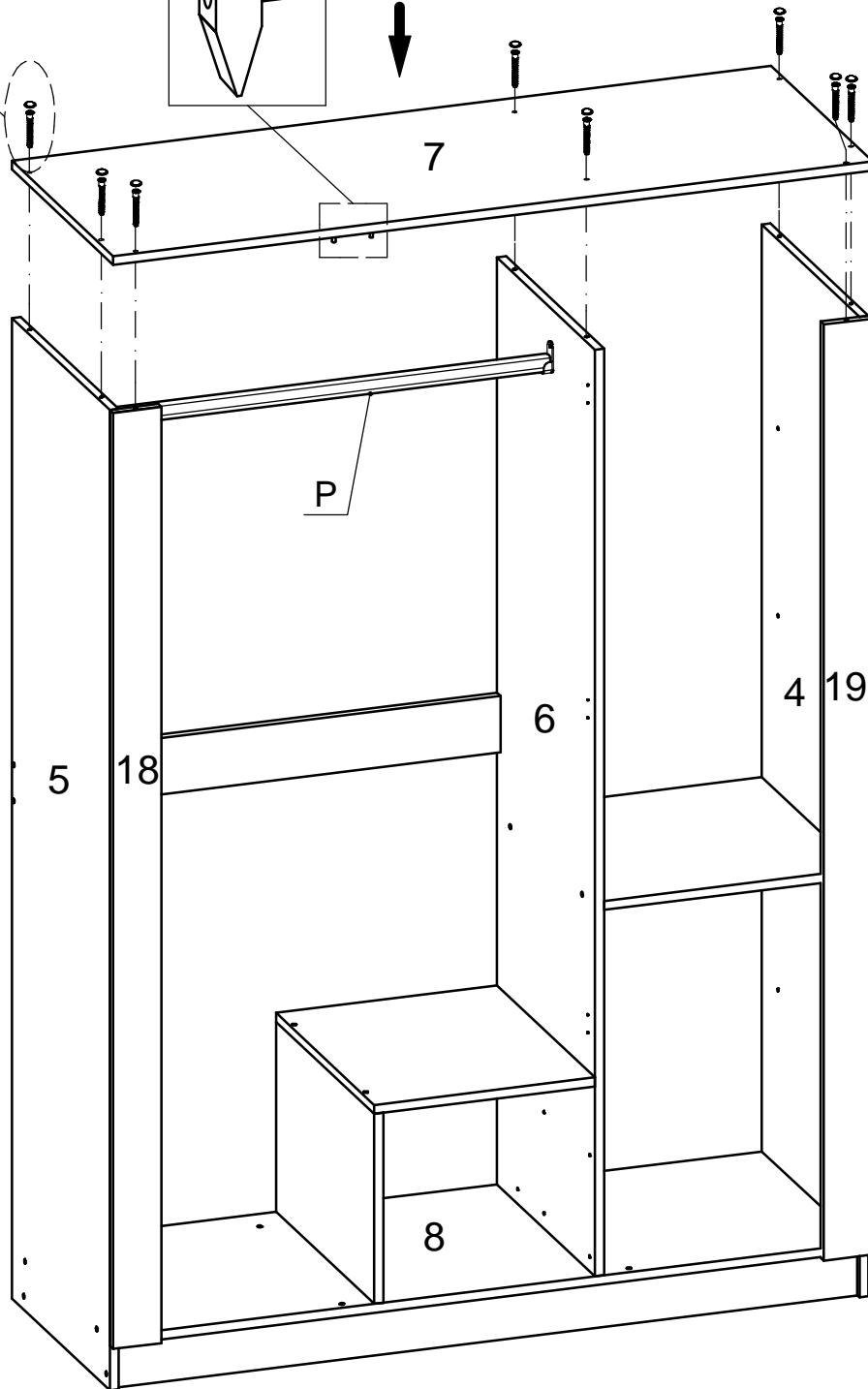
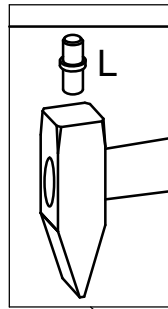
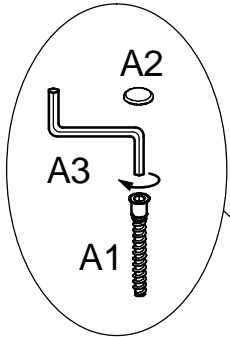
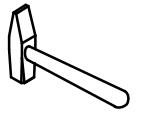

9



C x 5



D3 x 5

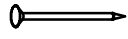

F x 194



N x 8

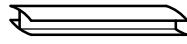

O1 x 1

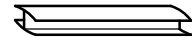

O2 x 1

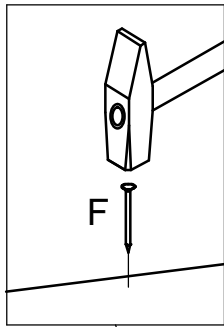
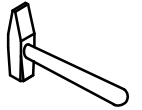
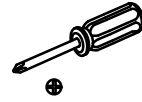

⚠ XX=YY≅90°

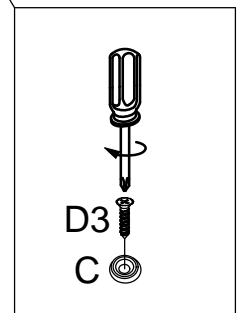
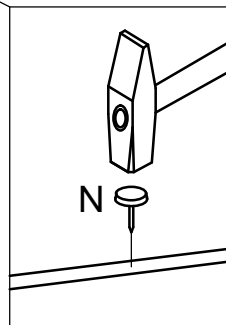
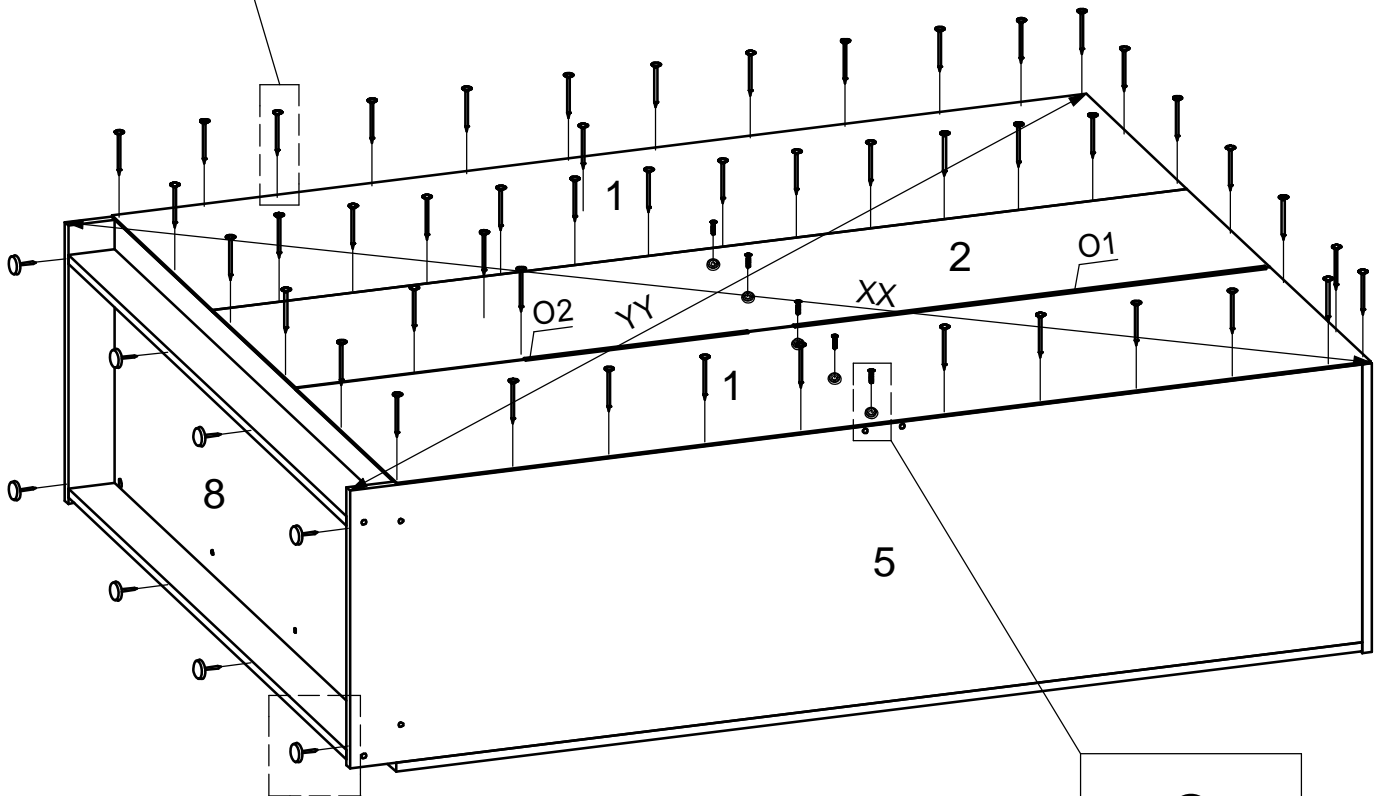

10

- D1 x 12
- D2 x 24
- D4 x 6
- H x 3
- M1.2 x 6
- M2.1 x 3
- M2.2 x 3

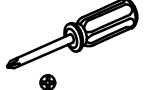
- K1 x 2
 - K2 x 2
- 

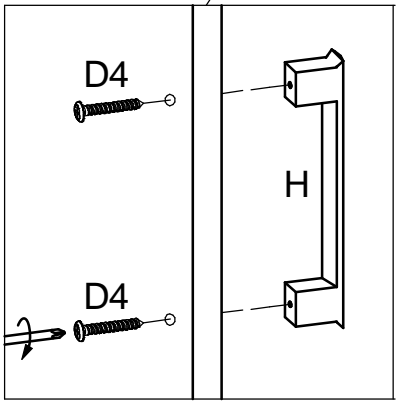
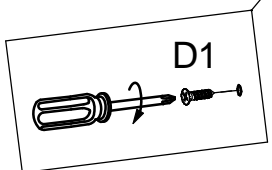
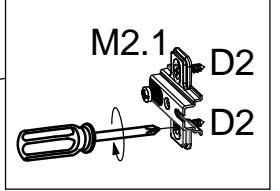
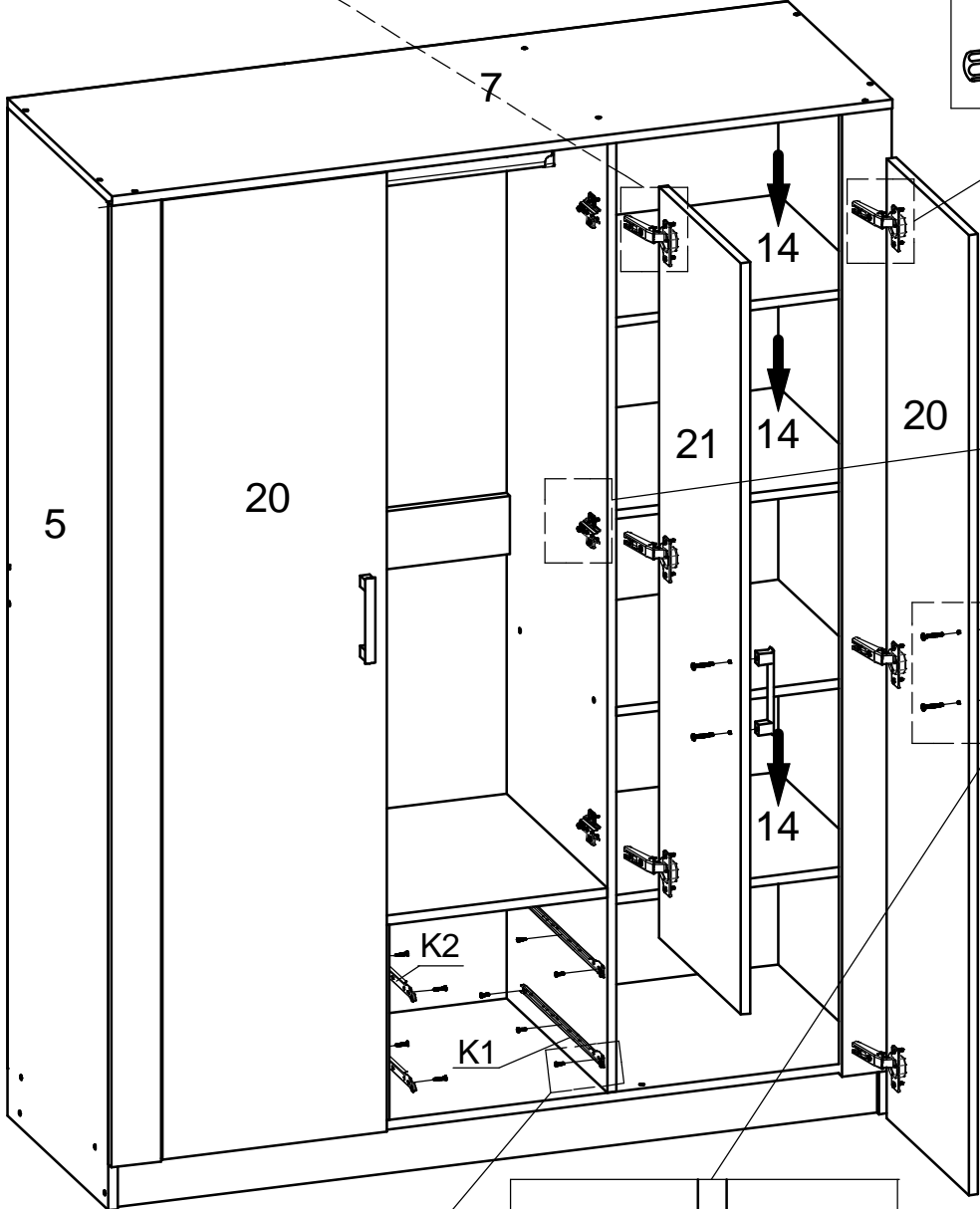
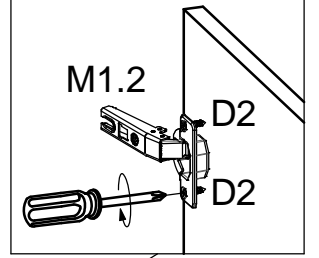
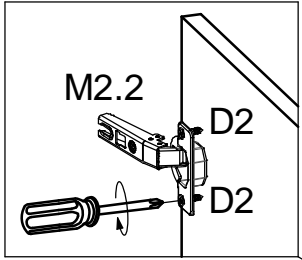

11

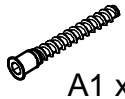

A1 x 8



A2 x 8



A3 x 1



B1 x 4

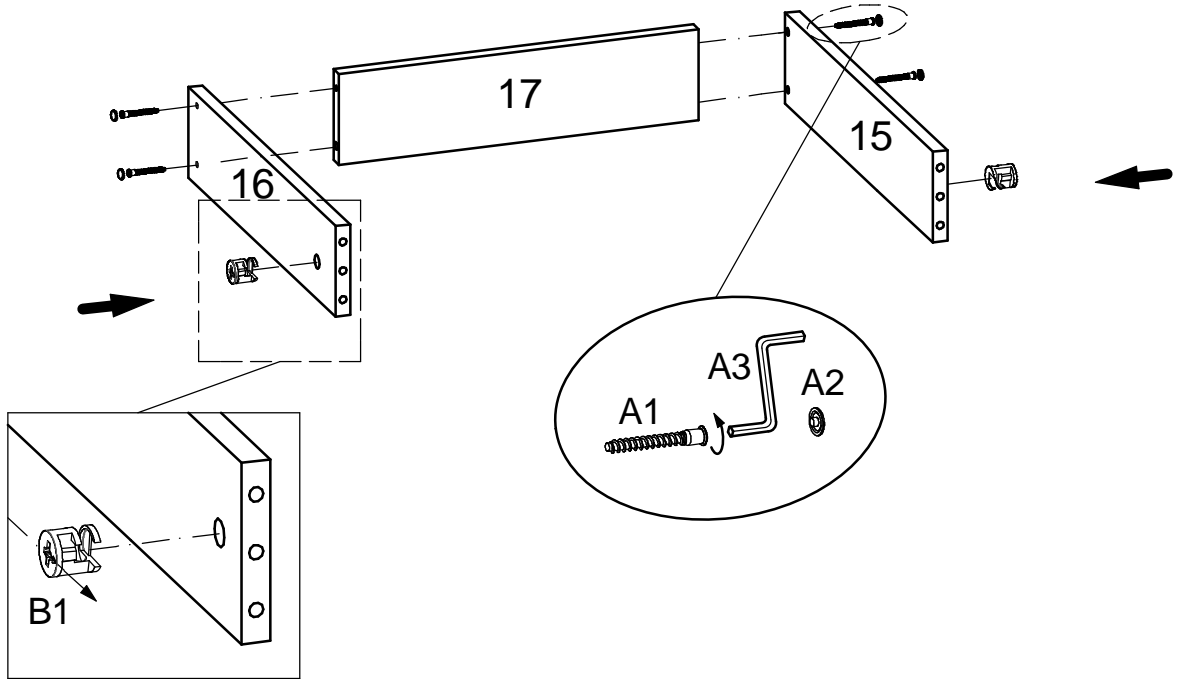

x 2

12



B2 x 4



B3 x 4



D4 x 4



G x 8

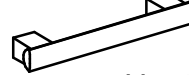

H x 2

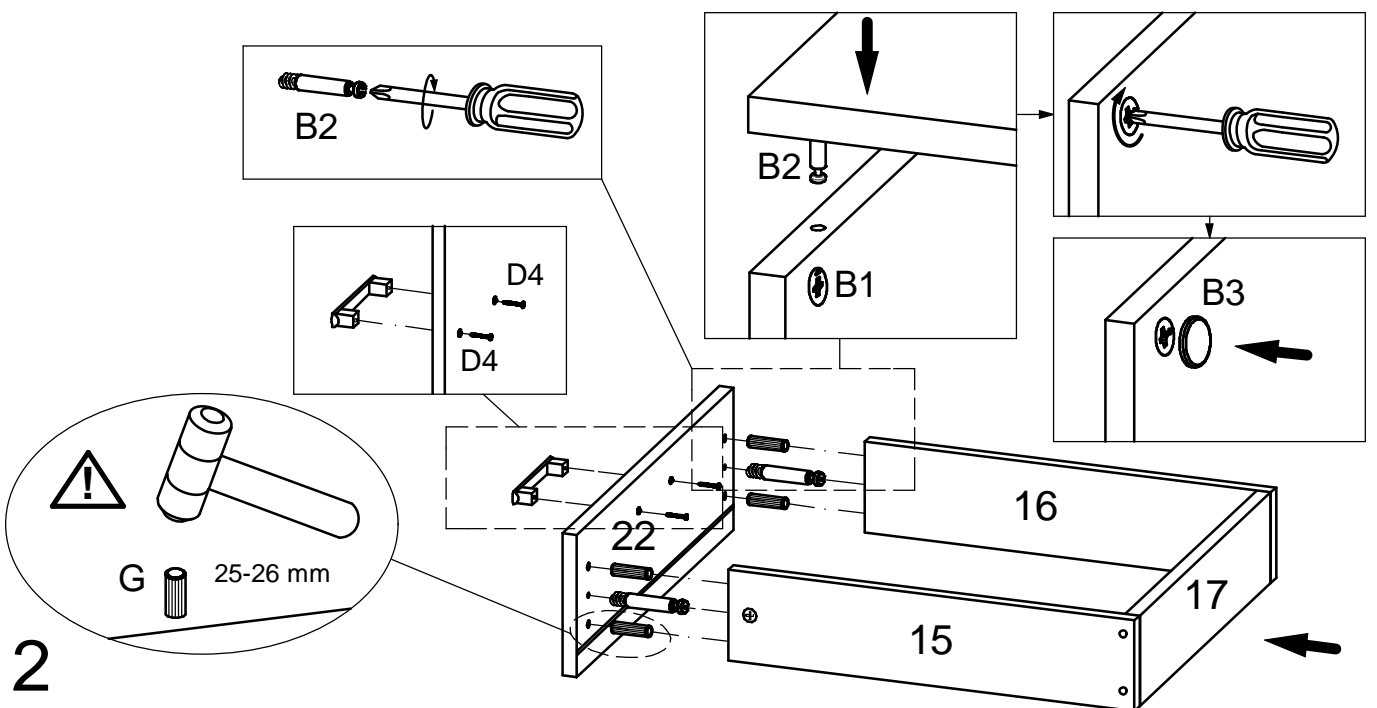
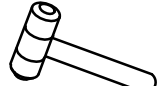
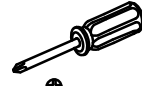

x 2

13

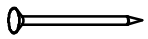

F x 44

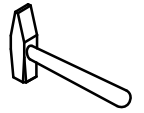

⚠ XX=YY≅90°

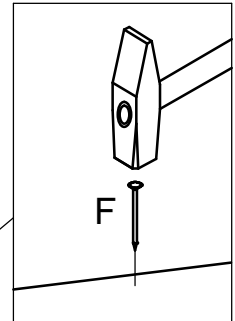
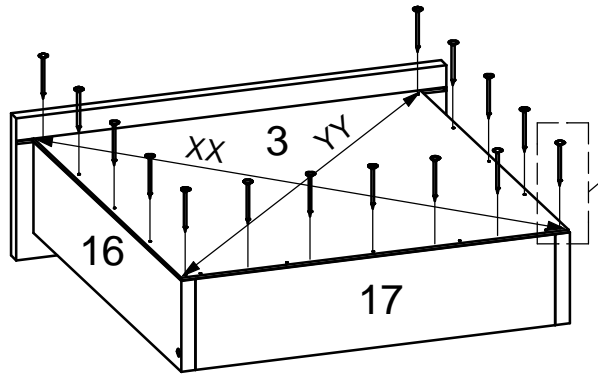

x 2

14



D2 x 12

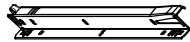

K3x2

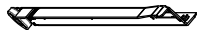

K4x2

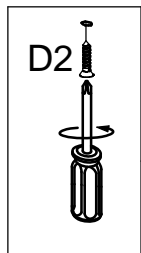
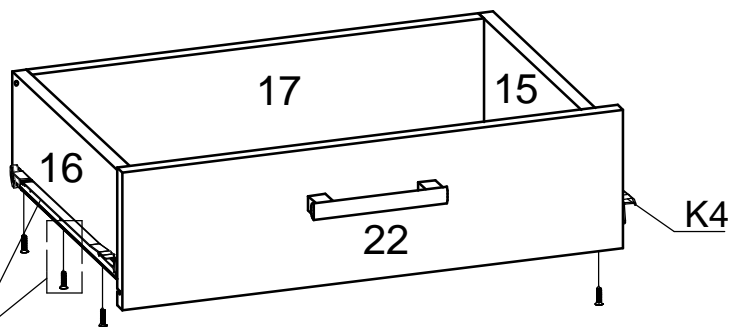
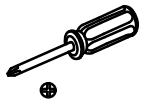

x 2

15

